

ZG-1088

Post Top Luminaires





HEAT DISSIPATION PERFORMANCE

Advanced FEA technology designs for the structure thermal transfer to guarantee the LED PCB and chips can use for long life.



Heat Distribution

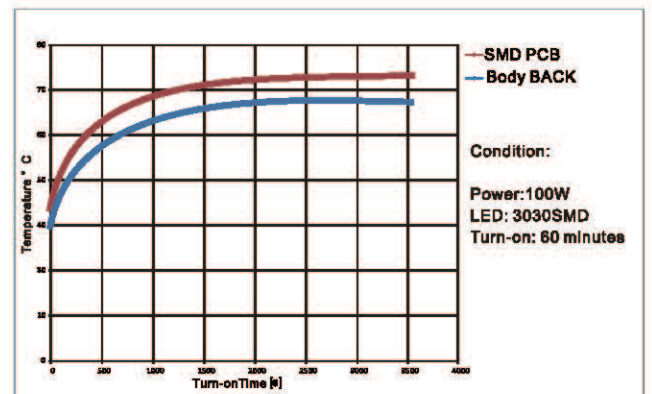

Temperature Rise

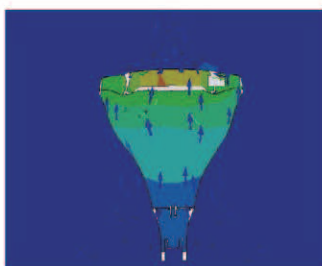

Heat Distribution

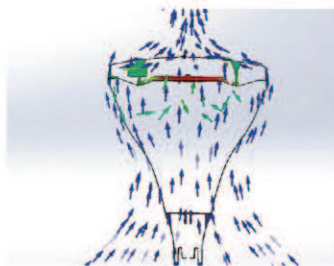

Thermal Effects to Air



Thermal Conductivity (Cutaway)

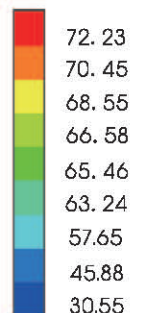

Product Overview



Light Distributions

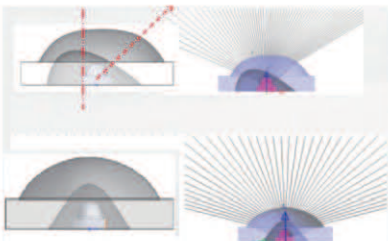
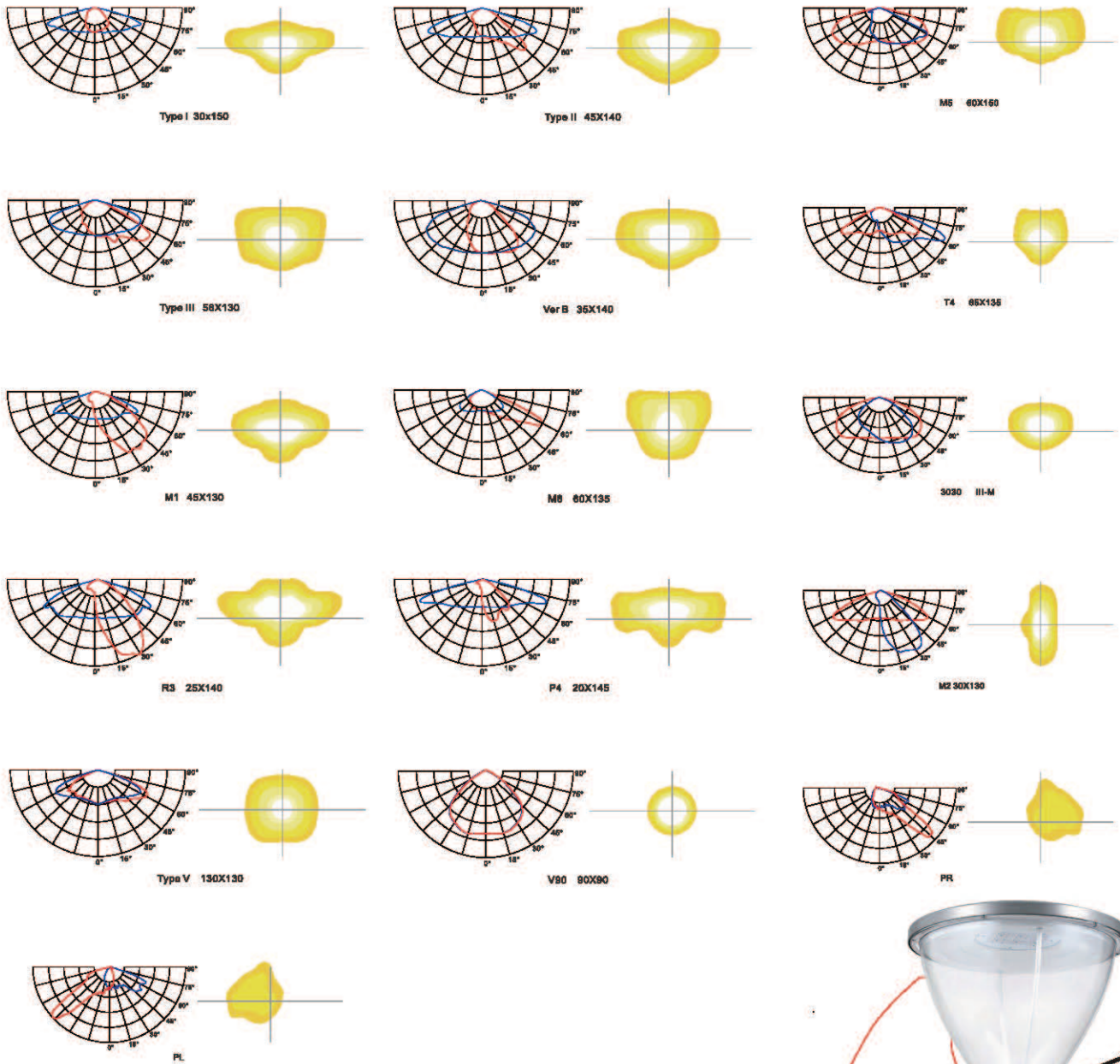

Asymmetric
Optics

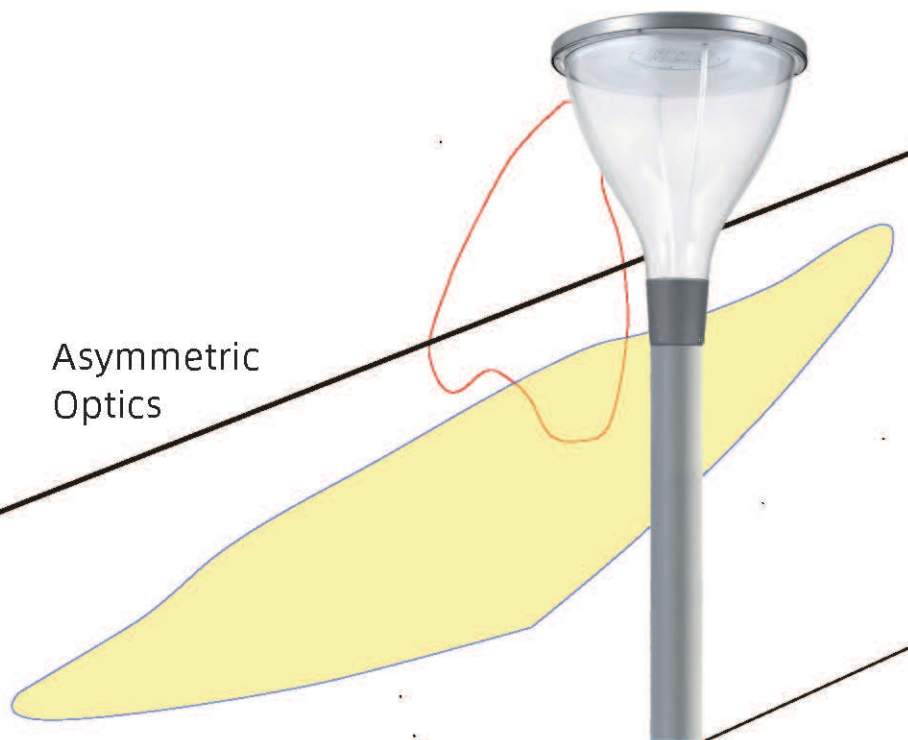

SUGGESTED INSTALLATION HEIGHT



CHARACTERS

Power	40W	60W	80W	100W
Protection Class	CLASS I/II			
IP/IK Rating	IP66, IK08			
Color Temperature	2200K-6500K	2200K-6500K	2200K-6500K	2200K-6500K
Efficiency	135-150 LM/W	135-150 LM/W	135-150 LM/W	135-150 LM/W
CRI	70/80	70/80	70/80	70/80
Input Voltage	AC 90-305V/347V/480V, 50/60Hz			
Driver Suggest	INVENTRONICS EBS, INVENTRONICS EUM			
Dimming	1-10V Dimming (Default) /Timer Dimming			
Surge Recommendation	10KV (Default) / 20KV (available on request)			
LED Type	LUMILEDS SMD LED			
LED Quantities 3030	64	96	144	160
Pcb Input Current (3030)	48V 725mA	96V 560mA	144V 510mA	120V 760mA
LED Quantities 5050	24	24	36	36
Pcb Input Current (5050)	66V 520mA	66V 820mA	88V 820mA	88V 1050mA
Mounting	On pole with 60 mm top diameter,, adaptor 76 mm top diameter can be chosen			
Material	Die casting with standard adc12 type aluminum, tempered glass, stainless 314 clips and screws. Clear polycarbonate with uv-resistant acrylic. Option for screen for asymmetrical light.			
Painting Color Suggest	RAL9007 Aluminum grey /Other Colors on request			
Available on request	NEMA socket (3/5/7pins), ZHAGA socket, Short cap, Photocell, NTC, OLC, DALI Dimming			
Weight	Net weight: 11kgs Gross weight: 12.5kgs			
Packing Size	610x610x750mm			

Smart Control System Optional

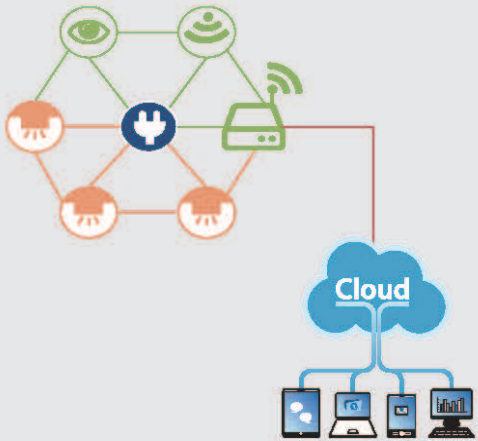

NEMA  **Zhaga**

LoRa   **ZigBee**



IP66    **Constant current discharge**

Unit : mm

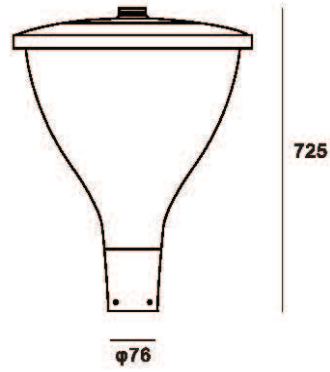

570

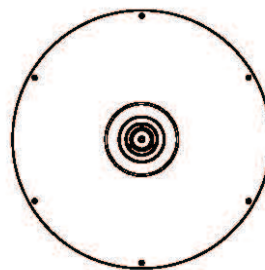
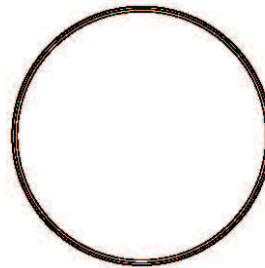

L ↔ N **6KV**

 **10KV**

ZG-1088

Post Top Luminaires





HEAT DISSIPATION PERFORMANCE

Advanced FEA technology designs for the structure thermal transfer to guarantee the LED PCB and chips can use for long life.



Heat Distribution

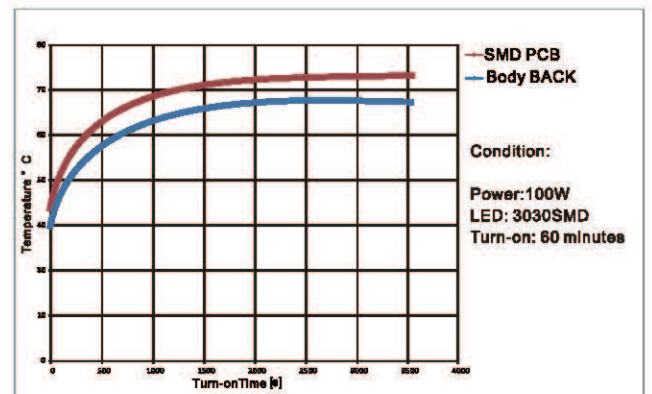

Temperature Rise

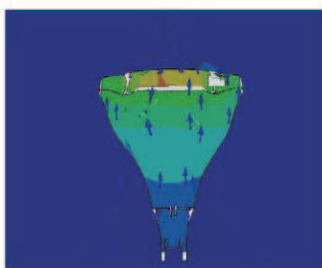

Heat Distribution

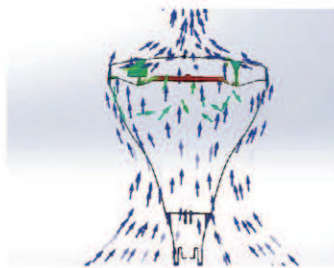

Thermal Effects to Air



Thermal Conductivity (Cutaway)

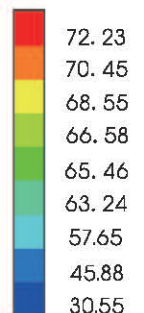

Product Overview



Light Distributions

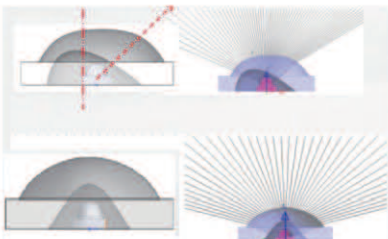
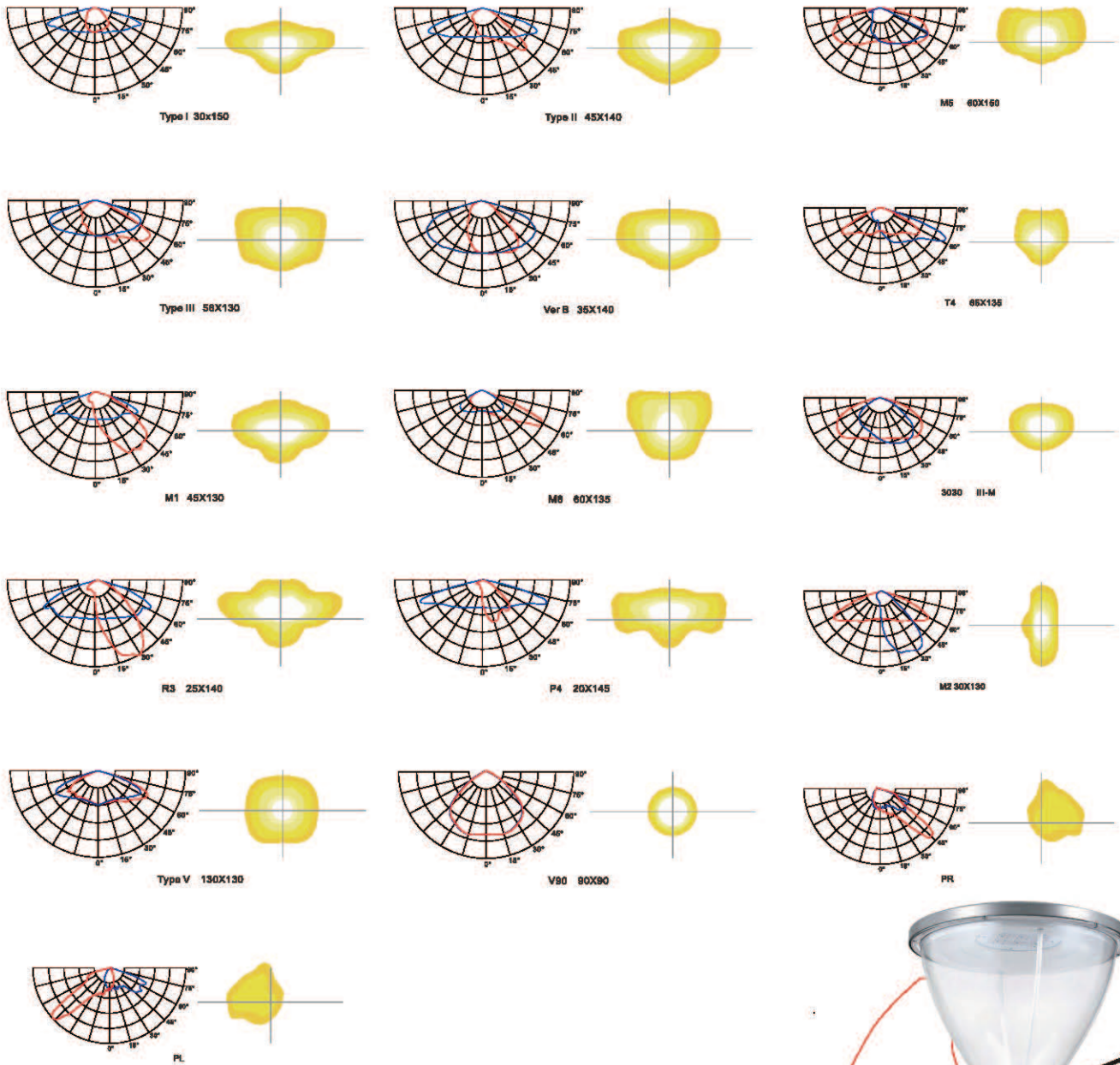

Asymmetric
Optics

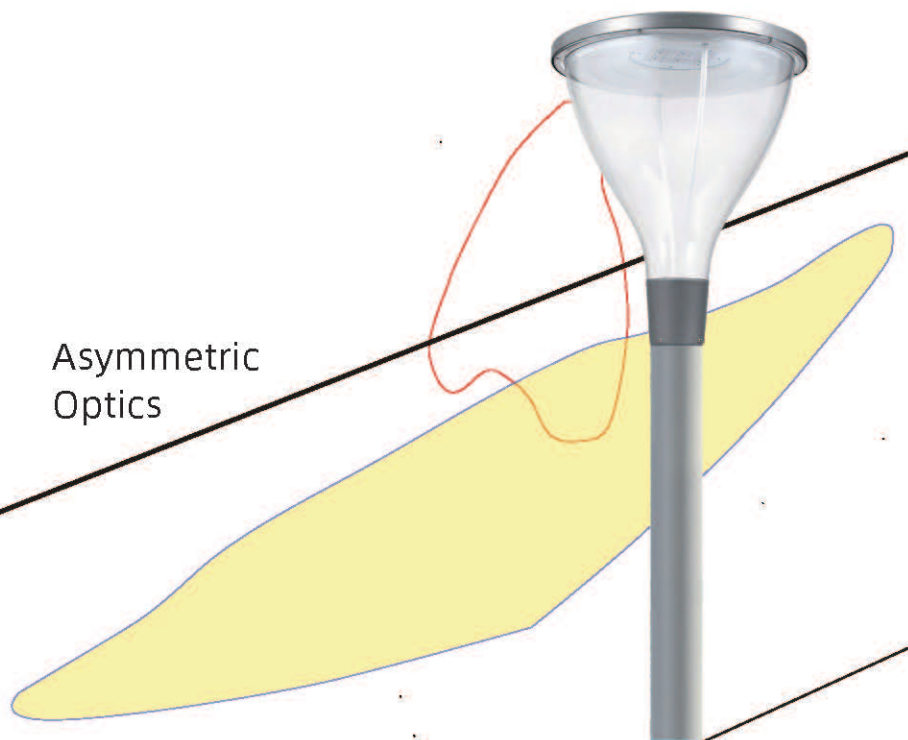

SUGGESTED INSTALLATION HEIGHT



CHARACTERS

Power	40W	60W	80W	100W
Protection Class	CLASS I/II			
IP/IK Rating	IP66, IK08			
Color Temperature	2200K-6500K	2200K-6500K	2200K-6500K	2200K-6500K
Efficiency	135-150 LM/W	135-150 LM/W	135-150 LM/W	135-150 LM/W
CRI	70/80	70/80	70/80	70/80
Input Voltage	AC 90-305V/347V/480V, 50/60Hz			
Driver Suggest	INVENTRONICS EBS, INVENTRONICS EUM			
Dimming	1-10V Dimming (Default) /Timer Dimming			
Surge Recommendation	10KV (Default) / 20KV (available on request)			
LED Type	LUMILEDS SMD LED			
LED Quantities 3030	64	96	144	160
Pcb Input Current (3030)	48V 725mA	96V 560mA	144V 510mA	120V 760mA
LED Quantities 5050	24	24	36	36
Pcb Input Current (5050)	66V 520mA	66V 820mA	88V 820mA	88V 1050mA
Mounting	On pole with 60 mm top diameter,, adaptor 76 mm top diameter can be chosen			
Material	Die casting with standard adc12 type aluminum, tempered glass, stainless 314 clips and screws. Clear polycarbonate with uv-resistant acrylic. Option for screen for asymmetrical light.			
Painting Color Suggest	RAL9007 Aluminum grey /Other Colors on request			
Available on request	NEMA socket (3/5/7pins), ZHAGA socket, Short cap, Photocell, NTC, OLC, DALI Dimming			
Weight	Net weight: 11kgs Gross weight: 12.5kgs			
Packing Size	610x610x750mm			

Smart Control System Optional

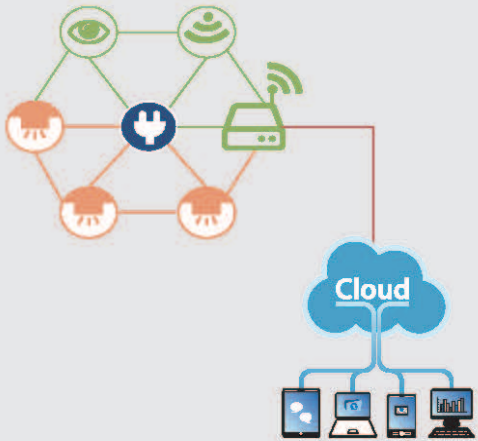

NEMA  **Zhaga**

LoRa   **ZigBee**



IP66    **Constant current discharge**

Unit : mm

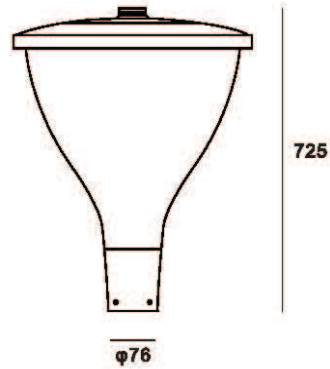

570

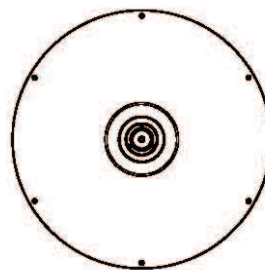
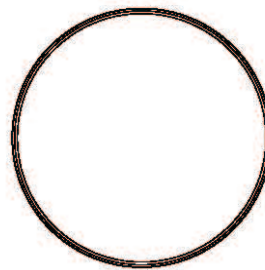

L ↔ N **6KV**

 **10KV**