

ZGSM SOLAR

All in Two Street Light Solution

PV6



ZGSM SOLAR



Single Version



Double Version

All in Two Designed Solar Solutions for Road and Urban Applications

Our solar street light for outdoor residential and public applications gives you a full customizable option to suit all your off-grid solar lighting requirements.

ZGSM SOLAR combined with LED luminaires, provides a reliable lighting solution with a high Ingress Protection level that withstands high ambient temperatures and vandalism. These luminaires are a sustainable off-grid performer with a superior lumen/ watt ratio.

The photovoltaic energy conversion is optimized by efficient Monocrystalline solar module technology to maximise solar energy. This, in conjunction with our Maximum Power Point Tracking (MPPT) charging system and our lithium energy storage technology, provides a state-of- the-art quality system, offering the required system autonomy and providing a long-lasting solution to operate in any of our very challenging environmental conditions.

ZGSM SOLAR offers a renewable lighting solution to operate in any of our very challenging environmental conditions.

Key Advantages

- All in two design.
- Microwave and human body induction control, realize intelligent power saving mode.
- Adopting MPPT intelligent controller, the charging efficiency is up to 96%.
- High-efficiency monocrystalline silicon solar panels with a conversion efficiency of 23%.
- Intelligent battery management, prolong the service life of lithium battery.
- Intelligent power mode, power adjustable automatically according to the battery level.
- 10-period programmable load power/ time control.
- Extensible to IoT remote communication monitoring function.



OFF-GRID AREAS



URBAN & RESIDENTIAL STREETS & ROADS

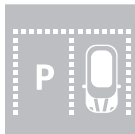

CAR PARKS



SQUARES & PEDESTRIAN AREAS



BIKE & PEDESTRIAN PATHS



SECURITY LIGHTING

Characteristics

GENERAL INFORMATION

Recommended installation height	5 to 12m (sensor is not available over 10m)
Components included	Monocrystalline Solar Panel Street Luminaire with Build-in Lithium Battery and Charge Controller Pole/Bracket/Arm (on request)
Autonomy days	5-7 days
System voltage	12/24V DC
Geographical location	Designed and optimised for locations with sunshine greater than 5 hours
Wind speed rating	126 km/hr
Working Mode	Factory Default- Work with Sensor Motion detected - 100% brightness, no motion detected - 20% brightness

SOLAR PANEL

Technology / Rated lifetime	Monocrystalline Solar Panel: 25 years / 80%
Peak rated wattage	60-160W(others on request)
Robustness	Hail and corrosion resistant
Material	Extruded aluminium Tempered glass 1m cable with female plug

POLE/BACKET/ARM (ON REQUEST)

Brackets for Solar Panels	Hot-dipped galvanised mild steel
Arm for Street Luminaire	Hot-dipped galvanised mild steel
Poles	Hot-dipped galvanised graded steel
Anchor Bolts	Hot-dipped galvanised graded steel

LIGHT DISTRIBUTIONS

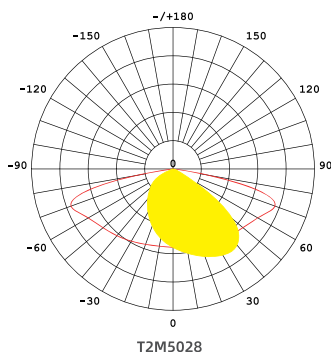

STREET LUMINAIRE

LIGHT FIXTURE	
LED	Customized high-efficiency LEDs
Optics	Type II
CRI	Ra>70 (Default) / Ra>80
CCT	2200-6500K
Housing	High pressure die-cast aluminium Extruded and stretched aluminum
Cover	UV-resistant Polycarbonate
Housing finish	Black (RAL9005)
Impact resistance	IK10
Type of protection	IP66
Pole diameter	50-60mm (suggestion)
Operating temperature range (Ta)	-15°C up to +70°C 10% ~ 90%RH
Lifespan L70 at 25 °C	100,000h
Mounting Type	Side entry

ENERGY STORAGE

Technology / Expected lifetime	Lithium Battery / 8 years
Capacity	307WH-768WH
Maintenance free	Yes
Working Temperature	-10°C up to +60°C
Material	LiFePO4

CHARGE CONTROLLER

Charge algorithm	Maximum Power Point Tracking (MPPT)
Rated lifetime	12 years
Optional Function	IoT Remote Communication
Daylight Sensor	Yes
Material	Extruded aluminium
Working Mode	Motion / PIR Sensor /Timer

CABLES/CONNECTORS

Cables(Standard)	2.5m 2x1.5m ² cable with male plug on one end
Connectors (Optional)	IP68 waterproof 2 Cores

Key Features

Overview



Fully integrated solar system, includes solar panel, luminaire (build in lithium battery and solar controller) and pole

Solar Module



Highly efficient monocrystalline solar panel technology to maximise solar energy conversion

Street Luminaire









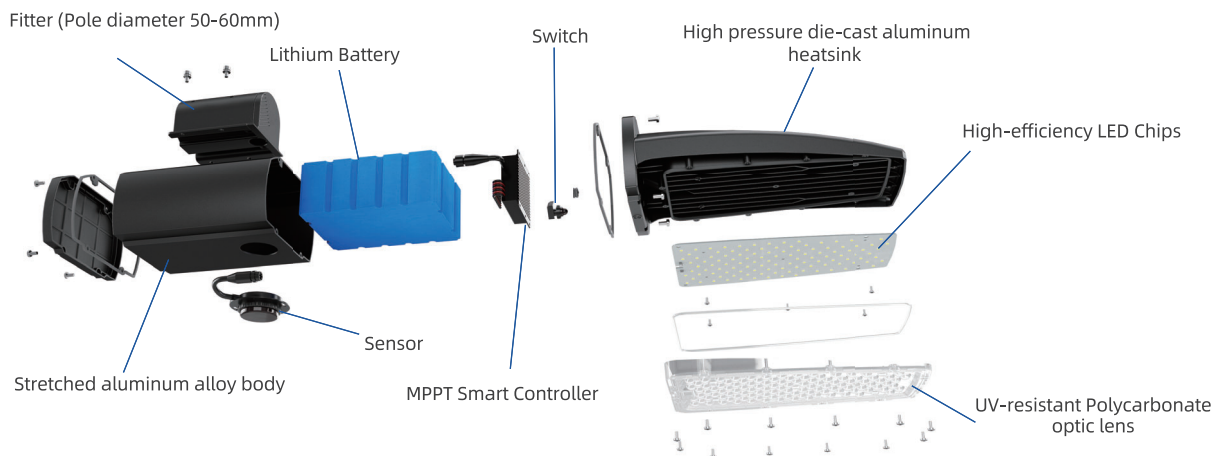

Highly efficient, performing and robust (IK10) LED street light luminaire (up to 210lm/W)

Luminaire Integrated Lithium Battery and Controller Unit

The luminaire integrates a high-quality new lithium iron phosphate (LiFePO₄) battery pack, a high-efficiency MPPT charge and discharge controller, and LED lighting components. The system has a simple structure yet delivers high performance. It is stable and easy to install and maintain.



Performance / Configuration Matrix

Photo	Model							
		Power	Efficiency	Lumen	Autonomy days	Sunshine	Lithium Battery	Solar Panels
	ZGSM-PV6-U1	30W	210 LM/W	6300 LM	5-7 days	5 hours	24AH/12.8V	60W/18V
		40W	210 LM/W	8400 LM	5-7 days	5 hours	30AH/12.8V	80W/18V
	ZGSM-PV6-U2	50W	210 LM/W	10500 LM	5-7 days	5 hours	36AH/12.8V	100W/18V
		60W	210 LM/W	12600 LM	5-7 days	5 hours	42AH/12.8V	120W/36V
	ZGSM-PV6-U3	70W	210LM/W	14700 LM	5-7 days	5 hours	24AH/25.6V	150W/36V
		80W	210LM/W	16800 LM	5-7 days	5 hours	30AH/25.6V	160W/36V

-The above values are calculated for products with a CCT greater than 4000K and a CRI of 70. For products with a CCT of less than 4000K, or a CRI greater than 75, the values are approximately 5% lower than those stated above, and the above values displayed are subject to a ±5% tolerance.
 -Custom solutions could be considered and are subject to design approval at the time of the project.

Packing Information

Model	Power	Part	Net Weight	Gross Weight	Pack Type	Carton Size	Package for Solar Panels	Package for Luminaires
ZGSM-PV6-U1	30W	Luminaire	6.8kgs	7.6kgs	1unit /ctn	595 x235 x195mm		
		Solar Panel	3.6kgs	7.6kgs	2units /ctn	875 x420 x72mm		
ZGSM-PV6-U2	40W	Luminaire	7.4kgs	8.2kgs	1unit /ctn	595 x235 x195mm		
		Solar Panel	4.5kgs	9.5kgs	2units /ctn	760 x600 x72mm		
ZGSM-PV6-U2	50W	Luminaire	8.2kgs	9.1kgs	1unit /ctn	665 x235 x195mm		
		Solar Panel	6.0kgs	12.7kgs	2units /ctn	790 x760 x72mm		
ZGSM-PV6-U2	60W	Luminaire	8.8kgs	9.7kgs	1unit /ctn	665 x235 x195mm		
		Solar Panel	6.7kgs	14.2kgs	2units /ctn	920 x790 x72mm		
ZGSM-PV6-U3	70W	Luminaire	10.0kgs	10.9kgs	1unit /ctn	770 x235 x195mm		
		Solar Panel	8.5kgs	17.7kgs	2units /ctn	1070 x790 x72mm		
	80W	Luminaire	11.2kgs	12.1kgs	1unit /ctn	770 x235 x195mm		
		Solar Panel	9.1kgs	18.8kgs	2units /ctn	1145 x790 x72mm		

-Note: For sample packing, add 20mm to each dimension (length, width, and height) of the solar panel cartons with wooden frame.
 -The above data is for reference only, the actual order packaging may be different, please consult ZGSM team to finalize the packaging data.

Dimensions

Luminaire

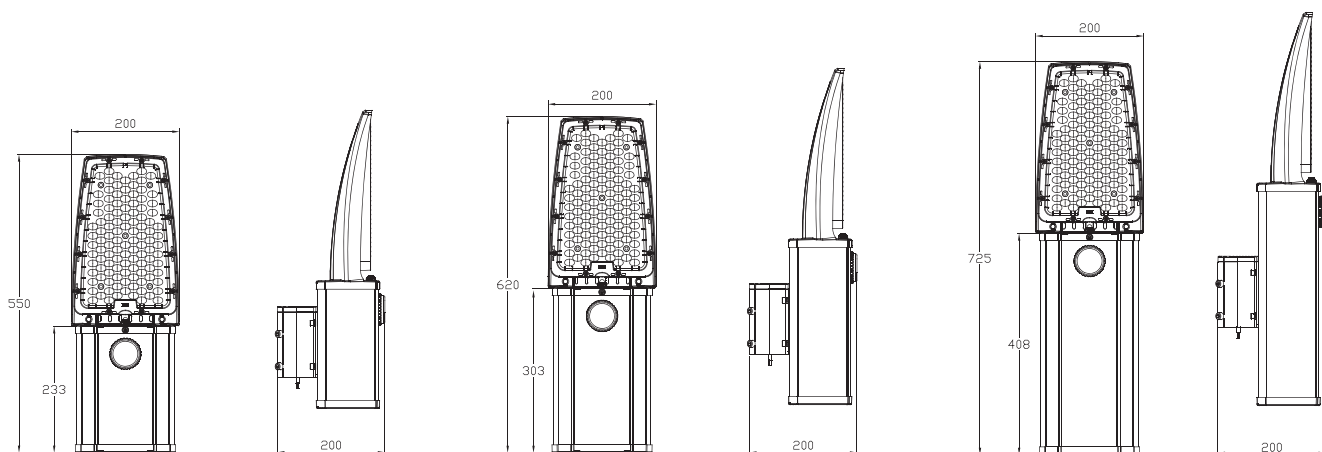

ZGSM-PV6-U1

ZGSM-PV6-U2

ZGSM-PV6-U3

Product dimension: mm

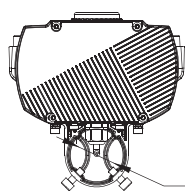

Suitable for 50-60mm pole

Solar Panels

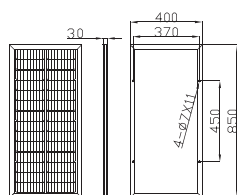

Mono 60W/18v

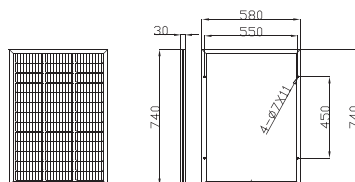

Mono 80W/18v

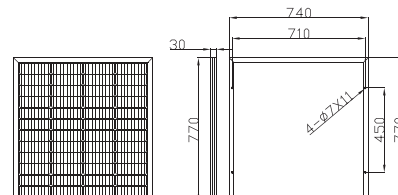

Mono 100W/18v

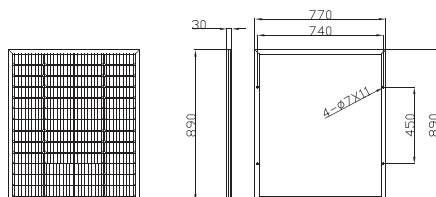

Mono 120W/36v

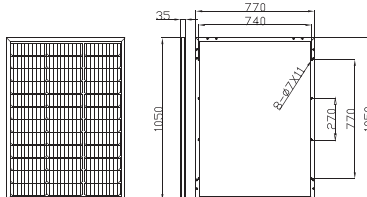

Mono 150W/36v

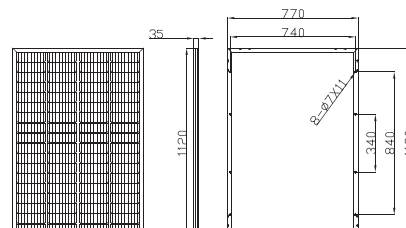

Mono 160W/36v

Optidim



Intelligent luminaire drivers are programmed if required in the factory with complex dimming profiles. Up to 6 combinations of time intervals and light levels are possible. This feature does not require any extra wiring. The period between switching on and switching off is used to activate the preset dimming profile.

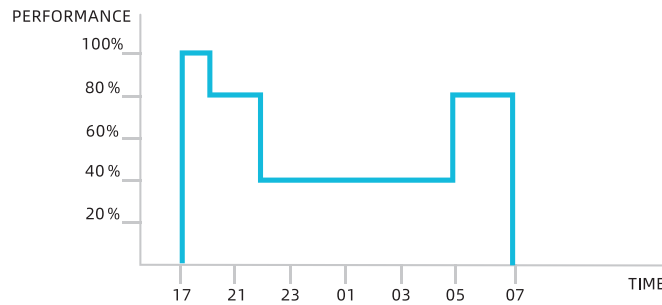

Autonomy Days



Autonomy Days refers to the number of nights/cycles a luminaire will continue to work without receiving a charge/being charged from the solar panel, due to adverse weather conditions. The number of autonomy days is aligned to the energy storage unit's depth of discharge resulting in sufficient capacity after a night/cycle.

Energy Storage



Lithium-ion

Lithium-ion based battery packs have the added advantage that they have a higher power density than lead, which means they have more available power for the same mass of a lead battery. This advantage, combined with the longer life expectancy and higher rate of depth of discharge (DOD), offering an attractive option for solar lighting applications, resulting in a longer battery lifetime.

Battery pack operating temperature: -10°C to $+60^{\circ}\text{C}$

Solar Module

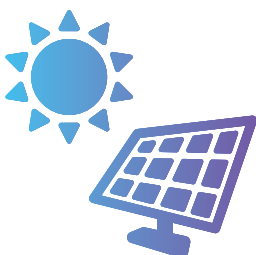

Monocrystalline Solar Panel

Monocrystalline silicon solar panels excel in solar street lighting with up to 23% efficiency, high heat resistance, and over 25 years of durability, ensuring consistent performance in various climates with minimal upkeep. Their effectiveness in low-light conditions also ensures reliable lighting, making them ideal for efficient and sustainable street lighting systems.

Solar Controller

MPPT Charge Controller

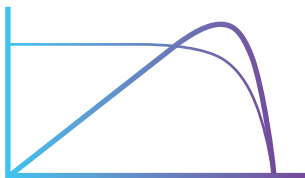

Using MovingTrack MPPT maximum power tracking technology, the tracking efficiency is higher and faster. Compared with PWM charge controller, MPPT charge controller can collect 30% more energy under cloudy conditions. A variety of intelligent power modes are available for choice, with load power adjustable automatically according to the battery level. Battery charge and discharge high and low temperature protection, with operating temperature settable. Multiple protections such as battery/PV reverse polarity protection, LED short-circuit/open-circuit/limited. Full aluminum housing, IP67 waterproof rating, applicable to a variety of harsh environments. Infrared wireless communication, allowing for setting/reading parameters, reading status, etc.

Solar Energy

Solar panel and battery sizing for solar street lights is determined by local daily sunlight hours. Our standard configurations are designed for areas with an average of 5 hours of sunlight per day. Check the world solar irradiance map to gauge sunlight in your area and contact us for a customized solar street light solution.

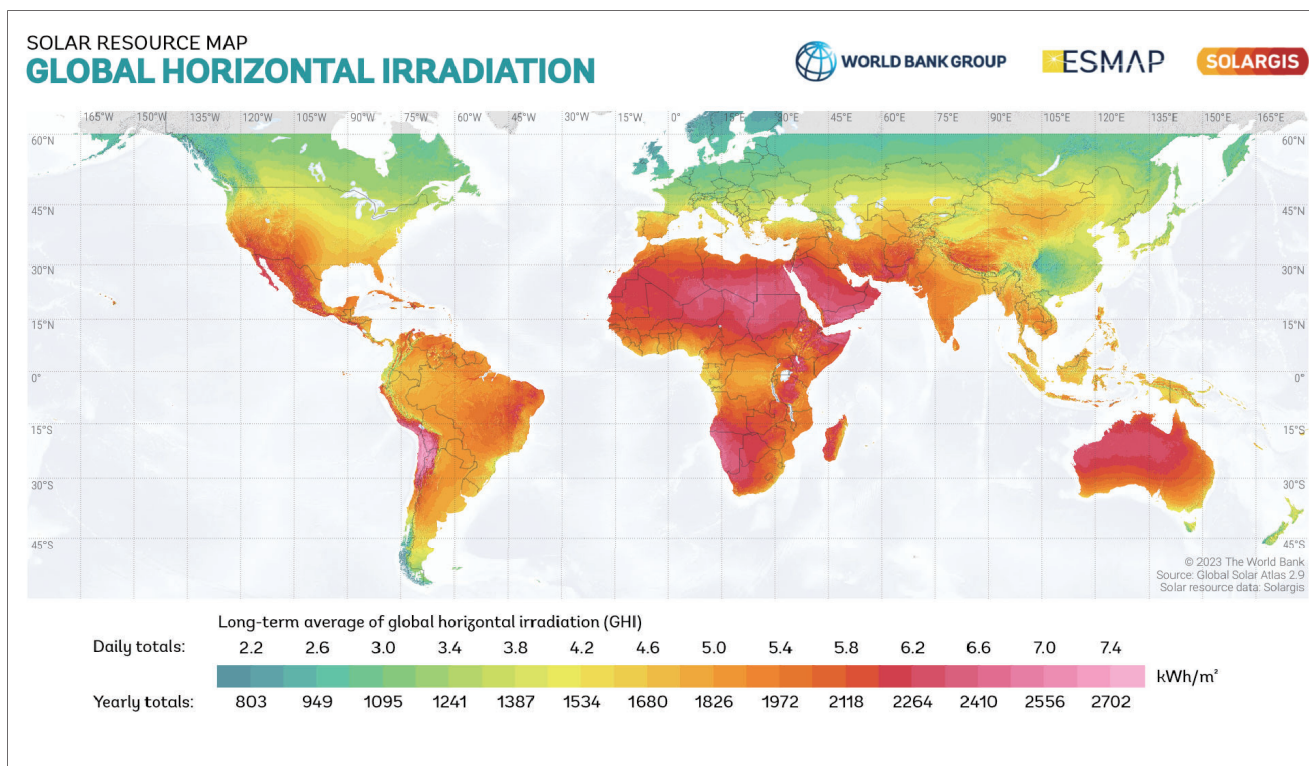

Integrated Motion/PIR Sensor

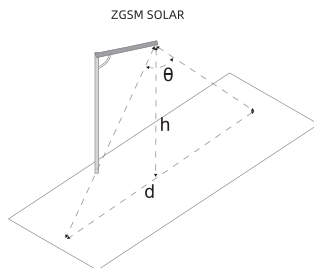
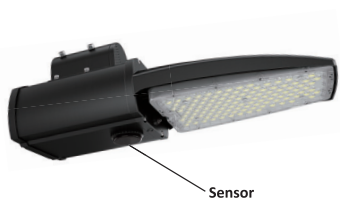

Inductive Type	θ (Angle)	h (Height of Lamp)	d (Inductive Width)
PIR Sensor	60°	6~8m	6~10m
Motion Sensor	65°	6~10m	7~10m

Pole on Request

Technical Information

Pole Size				Arm			Base Plate					Anchor Bolts			Pole Foundation		
H	d1	d2	T1	L	d3	∠	L1	L2	T2	K	Q1	L3	M	Q2	W1	W2	L4
5000	65	120	3.0	800	60	12°	250	177	10	20x42	4pcs	500	φ16	4pcs	500	500	600
6000	65	130	3.0	800	60	12°	280	198	12	20x42	4pcs	500	φ16	4pcs	560	560	600
7000	65	140	3.0	1000	60	12°	280	198	12	20x42	4pcs	500	φ16	4pcs	560	560	600
8000	75	165	3.0	1000	60	12°	320	226	14	24x50	4pcs	900	φ20	4pcs	640	640	1000
9000	75	175	3.5	1200	60	12°	320	226	16	24x50	4pcs	900	φ20	4pcs	640	640	1000
10000	75	185	4.0	1200	60	12°	320	226	16	26x54	4pcs	1100	φ22	4pcs	640	640	1200
12000	90	220	4.0	1500	60	12°	400	300	20	28x58	4pcs	1100	φ24	4pcs	800	800	1200

Abbreviations and Notes

Abbreviations	
Pole Size	Anchor Bolts
1. All dimensions are in mm	14. L3 = Bolt height
2. H = Overall height of pole	15. M = Bolt diameter
3. d1 = Top diameter of pole	16. Q2 = No. of bolts required/Pole.
4. d2 = Bottom diameter of pole	
5. T1 = Shaft Wall Thickness of pole	
Arm	Pole Foundation
6. L = Arm length	17. L4 = Deep of pole foundation
7. d3 = Diameter of arm	18. W1 = length of pole foundation
8. ∠ = Arm tilt angle	19. W2 = Width of pole foundation
Base Plate	Notes
9. L1 = Dimension of base plate	20. Materials: Q235
10. L2 = Distance between holes	21. Finish: Hot dip galvanized + Plastic spray
11. T2 = Plate Thickness	22. Maximum wind speed 126 Km/Hr
12. K = Hole Size	
13. Q1 = No. of holes	

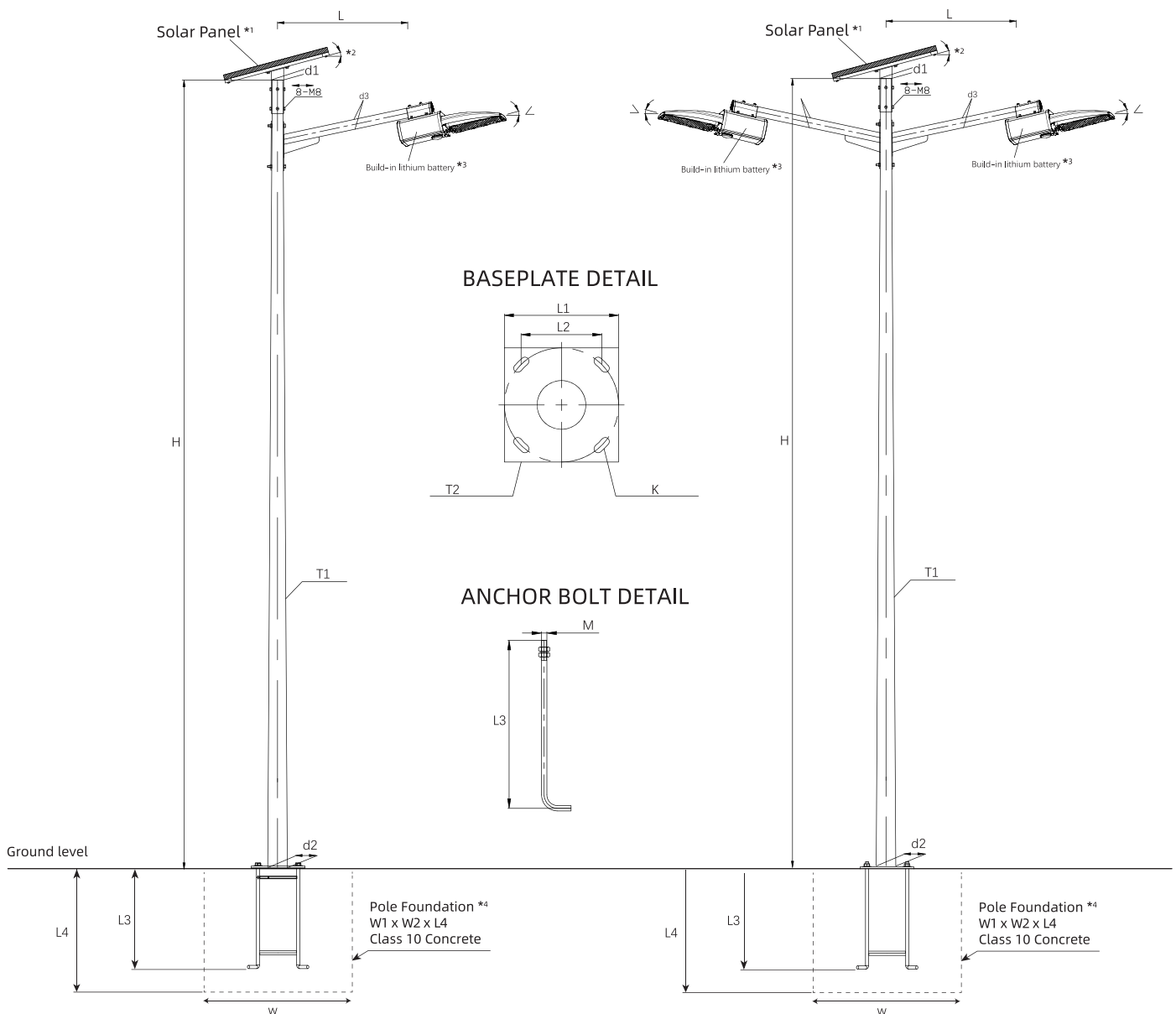

Please note:

- *1 Solar panel size varies according to different power requirements due to geographical locations.
- *2 The angle of inclination for solar panels is determined based on the geographic latitude of the installation site.
- *3 Depending on the autonomy days required, the size of the lithium battery will vary according to different power consumption needs.
- *4 Only indicative, dependent on soil condition. After evaluating site conditions, please contact certified structural engineer.